

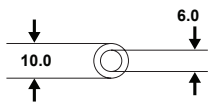







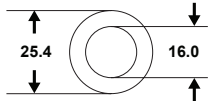

## SURVEY

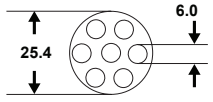
### Technical data of *atech* Al<sub>2</sub>O<sub>3</sub>- membranes

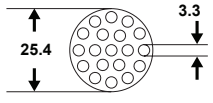
Support material	α-Al <sub>2</sub> O <sub>3</sub>
Membrane material	MF: α-Al <sub>2</sub> O <sub>3</sub> ; ZrO <sub>2</sub> ; TiO <sub>2</sub> UF: TiO <sub>2</sub> ; ZrO <sub>2</sub> ; Al <sub>2</sub> O <sub>3</sub>
Pore diameter / Molecular Weight Cut Off	1.2; 0.8; 0.4; 0.2; 0.1 μm    0.05 μm; 150 kD; 100 kD; 25 kD; 15 kD; 5 kD; 1 kD
Overall length	up to 1500 mm
pH- stability	0 to 14
All membrane designs are suitable for steam sterilisation ≥ 121°C / 249.8° F.	

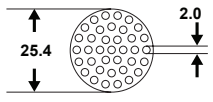
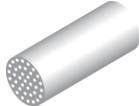
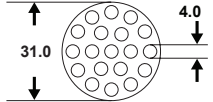
Type	Design (mm)	Amount of channels	Length (mm)	Filter surface per element (m <sup>2</sup> )	Illustration
1/6		1	1000	approx. 0.019	
			1200	approx. 0.023	
1/16		1	1000	approx. 0.05	
			1200	approx. 0.06	
7/6		7	1000	approx. 0.13	
			1200	approx. 0.16	
19/3.3		19	1000	approx. 0.20	
			1200	approx. 0.24	
37/2		37	1000	approx. 0.23	
			1200	approx. 0.28	
19/4		19	1000	approx. 0,24	
			1200	approx. 0,29	

## SURVEY

### Technical data of *atech* Al<sub>2</sub>O<sub>3</sub>- membranes

Support material	α-Al <sub>2</sub> O <sub>3</sub>
Membrane material	MF: α-Al <sub>2</sub> O <sub>3</sub> ; ZrO <sub>2</sub> ; TiO <sub>2</sub> UF: TiO <sub>2</sub> ; ZrO <sub>2</sub> ; Al <sub>2</sub> O <sub>3</sub>
Pore diameter / Molecular Weight Cut Off	1.2; 0.8; 0.4; 0.2; 0.1 μm    0.05 μm; 150 kD; 100 kD; 25 kD; 15 kD; 5 kD; 1 kD
Overall length	up to 1500 mm
pH- stability	0 to 14
All membrane designs are suitable for steam sterilisation ≥ 121°C / 249.8° F.	

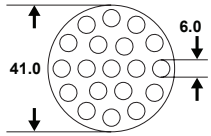
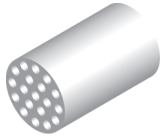
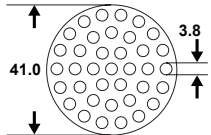
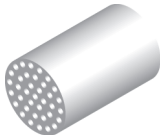
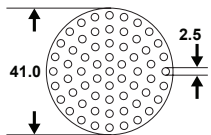
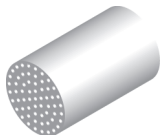
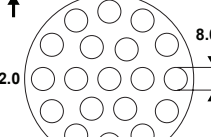
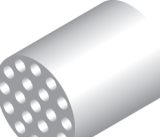
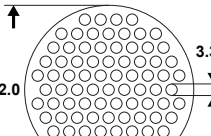
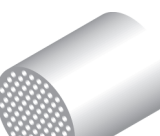
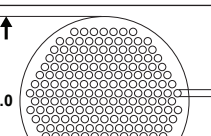
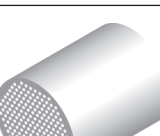
Type	Design (mm)	Amount of channels	Standard length (mm)*	Filter surface per element (m <sup>2</sup> )	Illustration
19/6		19	1200	approx. 0.43	
			1500	approx. 0.54	
37/3.8		37	1200	approx. 0.53	
			1500	approx. 0.67	
61/2.5		61	1200	approx. 0.58	
			1500	approx. 0.72	
19/8		19	1200	approx. 0.57	
			1500	approx. 0.72	
85/3.3		85	1200	approx. 1.06	
			1500	approx. 1.32	
211/2		211	1200	approx. 1.59	
			1500	approx. 1.99	

\*other lengths on request

General information

atech tubular ceramic membranes meet regulatory requirements for food contact according European Regulation no. 1935/2004 and FDA requirements 21 CFR, 170-199.

atech crossflow membranes modules are authorized to bear the 3-A symbol for complying fully with the 3-A Sanitary Standard (certificate no. 1680)